

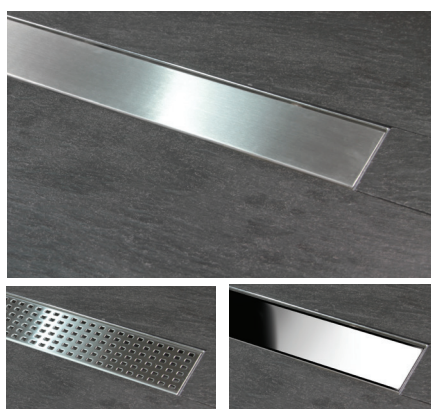

dus rigola **DRY50** **LINIAR**

o singura panta

Rigola montata la un capăt al duşului capteaza apa cu ajutorul unei singure pante de scurgere. Dusurile walk-in cu drenaj liniar oferă o estetică a liniilor simple si de actualitate. Un dus integrat, confortabil și funcțional realizat cu materiale de înaltă calitate.



DRY50 LINIAR

Doua tipuri de sifoane de scurgere: PREMIER o FLAT.

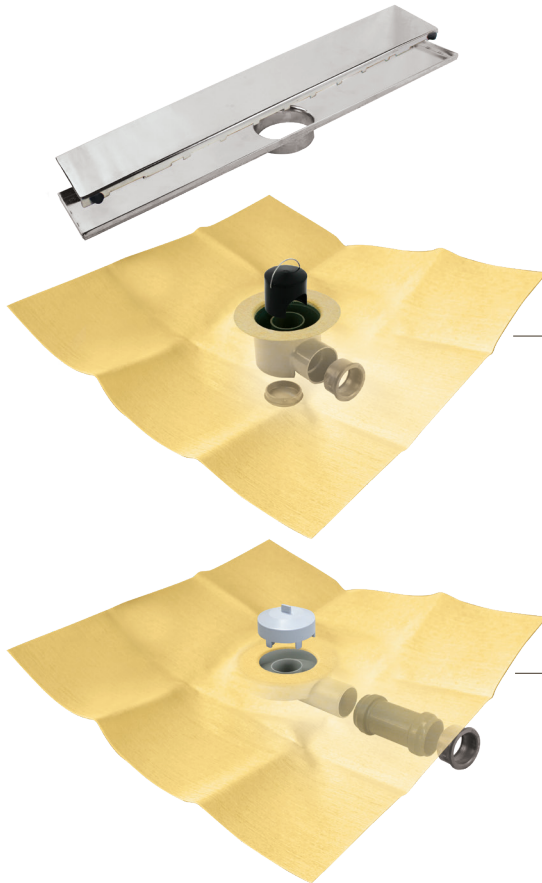

DRY50 LINIAR PREMIER

DRY50 LINIAR FLAT



OPTIUNEA DE PERSONALIZARE CU LASER

Gratarele liniare cu finisaj OTEL si CHROME pot fi gravate folosind o tehnica laser, cu sigla companiei. Pentru conditii consultați Departamentul comercial.

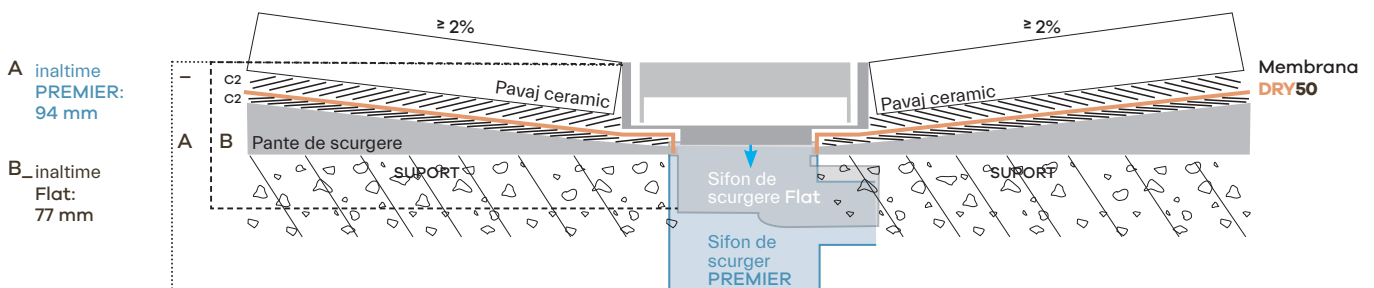

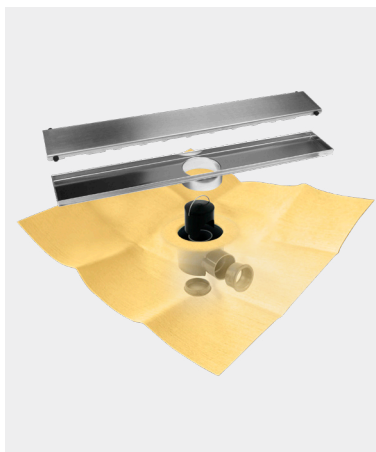

referinta	denumire	lungime gratar	membrana
544010908	•DRY50 LINIAR PREMIER 60 otel	60 cm	1,2 x 2 m
544011011	•DRY50 LINIAR PREMIER 60 chrome		
544010823	•DRY50 LINIAR PREMIER 60 squares		
544010915	•DRY50 LINIAR PREMIER 70 otel	70 cm	1,5 x 2 m
544010960	•DRY50 LINIAR PREMIER 70 chrome		
544010830	•DRY50 LINIAR PREMIER 70 squares		
544010922	•DRY50 LINIAR PREMIER 80 otel	80 cm	1,5 x 2 m
544010977	•DRY50 LINIAR PREMIER 80 chrome		
544010847	•DRY50 LINIAR PREMIER 80 squares		
544010939	•DRY50 LINIAR PREMIER 90 otel	90 cm	1,5 x 2 m
544010984	•DRY50 LINIAR PREMIER 90 chrome		
544010854	•DRY50 LINIAR PREMIER 90 squares		
544010946	*DRY50 LINIAR PREMIER 100 otel	100 cm	1,5 x 2 m
544010991	*DRY50 LINIAR PREMIER 100 chrome		
544010861	*DRY50 LINIAR PREMIER 100 squares		
544010953	*DRY50 LINIAR PREMIER 120 otel	120 cm	1,5 x 2 m
544011998	*DRY50 LINIAR PREMIER 120 chrome		
544011004	*DRY50 LINIAR PREMIER 120 squares		

Kit de rigola sifonica dus cu gratar liniar si membrana impermeabila DRY50 termosudata la corpul sifonului PREMIER.

Evacuare: orizontala si verticala (Ø 40/50H_54 l/minut).

Inaltime: 82 mm.

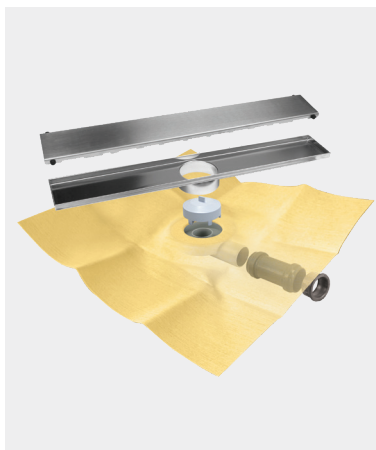

referinta	denumire	lungime gratar	membrana
544011028	•DRY50 LINIAR FLAT 60 otel	60 cm	1,2 x 2 m
544011110	•DRY50 LINIAR FLAT 60 chrome		
544011035	•DRY50 LINIAR FLAT 60 squares		
544011066	•DRY50 LINIAR FLAT 70 otel	70 cm	1,5 x 2 m
544011165	•DRY50 LINIAR FLAT 70 chrome		
544011042	•DRY50 LINIAR FLAT 70 squares		
544011073	•DRY50 LINIAR FLAT 80 otel	80 cm	1,5 x 2 m
544011103	•DRY50 LINIAR FLAT 80 chrome		
544011059	•DRY50 LINIAR FLAT 80 squares		
544011080	•DRY50 LINIAR FLAT 90 otel	90 cm	1,5 x 2 m
544011172	•DRY50 LINIAR FLAT 90 chrome		
544011141	•DRY50 LINIAR FLAT 90 squares		
544011097	*DRY50 LINIAR FLAT 100 otel	100 cm	1,5 x 2 m
544011189	*DRY50 LINIAR FLAT 100 chrome		
544011134	*DRY50 LINIAR FLAT 100 squares		
544011127	*DRY50 LINIAR FLAT 120 otel	120 cm	1,5 x 2 m
544012513	*DRY50 LINIAR FLAT 120 chrome		
544011158	*DRY50 LINIAR FLAT 120 squares		

Kit rigola sifonica dus cu gratar liniar si membrana impermeabila DRY50 termosudata la corpul sifonului FLAT.

Evacuare: orizontala (Ø 40/50H_30 l/minut).

Inaltime: 65 mm.

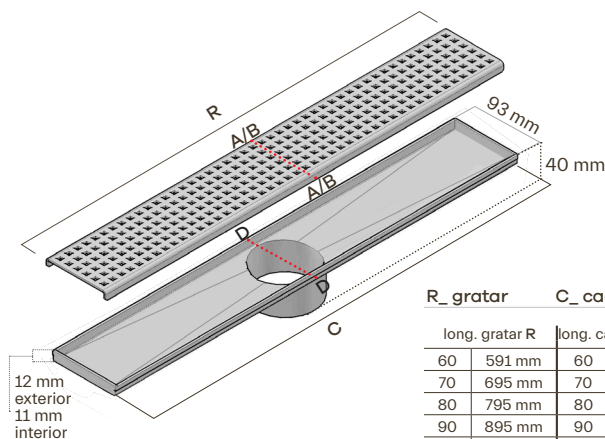
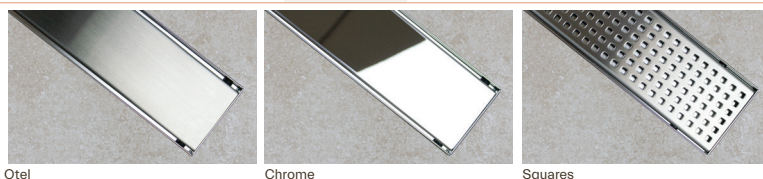
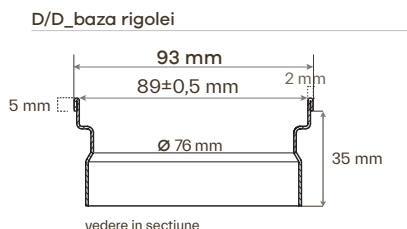
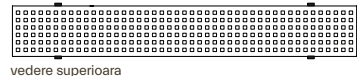
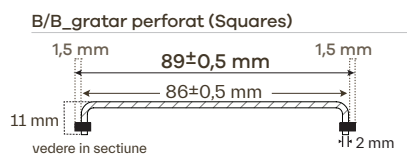
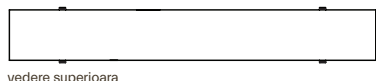
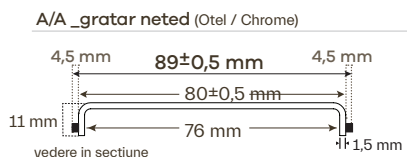

R_ gratar		C_ cadru rigola	
long. gratar R		long. cadru rigola C	
60	591 mm	60	596 mm
70	695 mm	70	700 mm
80	795 mm	80	800 mm
90	895 mm	90	900 mm
100	995 mm	100	1000 mm
120	1195 mm	120	1200 mm

pozitionarea sifonului pe membrana DRY50

Versiunea descentrata vertical

Sifonul de scurgere este termosudat de membrana impermeabila de forma descentrata 40 cm in zona cea mai lunga si centrat in zona mai ingusta.

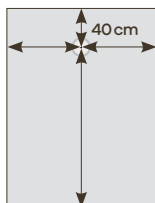

*

Versiunea descentrata orizontal

Sifonul de scurgere este termosudat de membrana impermeabila de forma descentrata 40 cm in zona cea mai ingusta si centrat in zona cea mai lunga.

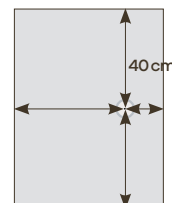

NOTA: este posibila montarea sifonului in orice zona a membranei (comanda superioara a 50 unitati).